

Com



profim



"Com is a cohesive system of compatible elements designed together to produce a variety of finished chairs. No two situations are identical, therefore in an ideal world one would be able to create ones environment exactly to fit ones needs. This is the thinking behind Com, one system that produces many different finished chairs."

Paul Brooks
Product Designer

Functionality in 792 options.

Simple form, advanced functionality

Com is a modern version of a multifunctional chair that is simple in form but versatile in use. The multitude of elements available in the collection allows you to create unique configurations that will stylistically match any space.







From the left: K32VN1, K12CV, K13V2 C, K21V3 2P, K42V1 2P, K13H, K31H 2PB, K42V3, K11L3.



Unlimited space

Com includes a wide range of elements that enable linking, numbering and stacking the chairs. It is particularly useful for large events.





Optional chair and row numbering allows event participants to locate their seats easily and keeps the area of bigger events in order.

Versatile and comfortable

Lecture halls, conference rooms, canteens. The finish you choose for the chair defines its character, adapting it stylistically to the room and adding comfort.





Several dozens of different upholstery designs available, also quilted ones (which adds a 3D effect), to create a truly unique product.



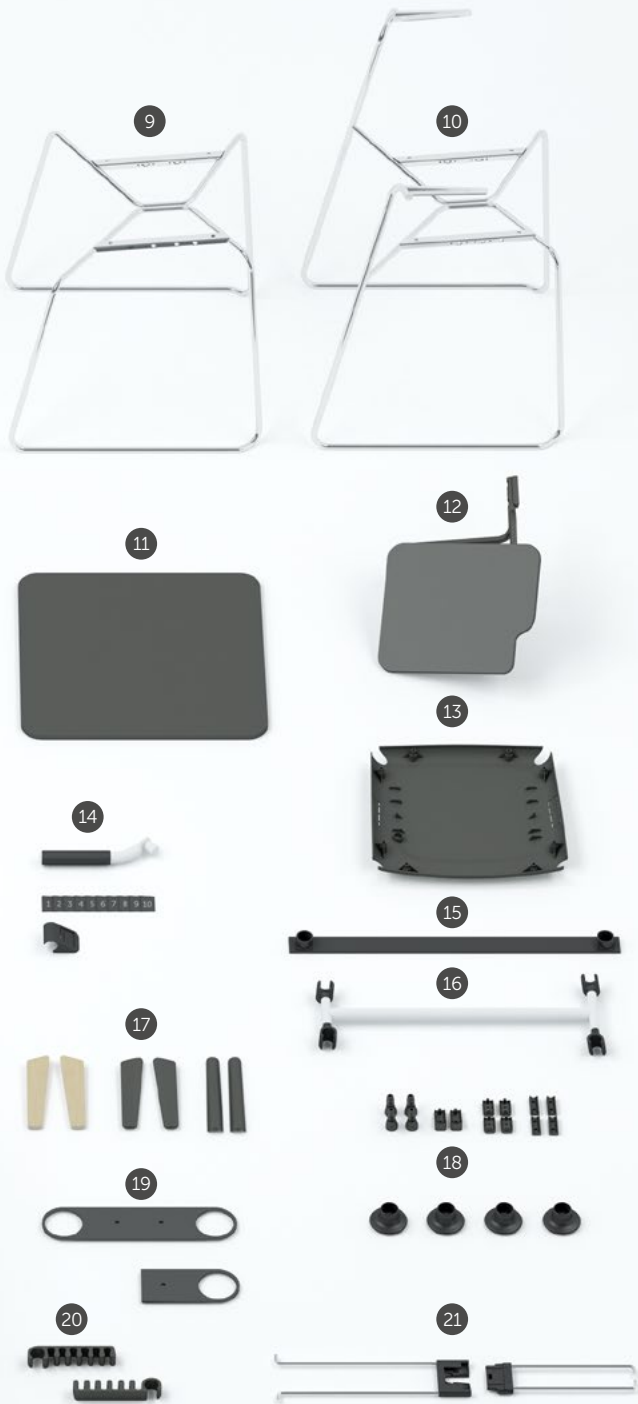

Your imagination is the only limit

Several frame designs, shapes and different shell finishes – all in all 792 possible versions to give any conference room an inimitable look.

- 1 4-legged frame
- 2 4-legged frame with armrests
- 3 cantilever with stacking option
- 4 cantilever with armrests and stacking option
- 5 bench frame
- 6 reversed cantilever
- 7 3 shapes of plywood shell, seat and backrest pads; fully upholstered; with cut-out
- 8 bar stool
- 9 wire frame with stacking option
- 10 wire frame with armrests and stacking option
- 11 bench table top
- 12 chair writing tablet
- 13 seat cover
- 14 numbering
- 15 "anti-panic" connector for rows
- 16 "anti-panic" connector for chairs
- 17 armpads
- 18 glides
- 19 distance keeping elements for benches
- 20 linking part (cantilever version)
- 21 linking part (4-legged version)

Safety and order

The anti-panic system is a method of arranging single chairs and entire rows into comprehensive auditoriums, which keeps the users safe in case of emergency. The system complies with EN ISO 14703 standards.



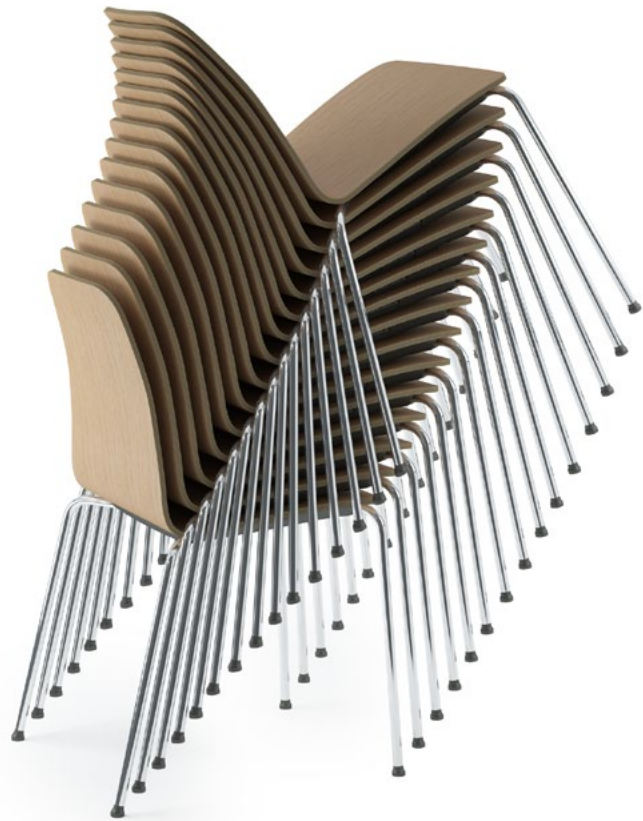

The possibility of stacking up to 15 chairs (depending on the selected option) minimizes storage space.

Flawless design

The design of Com chairs includes a number of solutions that facilitate everyday use of the product. The handle (optional), incorporated into the backrest, makes carrying the chairs easier, and thanks to the cantilever frame they can be placed on tables for quicker floor cleaning.

The collection is accompanied by a special trolley designed to move chairs from one room to another. Com is a useful, carefully designed product – and a great value for money, too.





Configure your product

When ordering, please use code symbols.

Com



Shell type



Plywood

K1



Plywood,
upholstered
seat pad

K2



Plywood,
upholstered seat
and backrest
pads¹

K3



Fully upholstered

K4

Shell shape



Rounded

1



Rectangular

2



Waisted

3

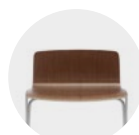

Bar stool²

2

Frame



Legs

H



Reversed
cantilever³

V2



Cantilever
without stacking
option³

VN1



Cantilever
with stacking
option³

V1



Wire frame³

V3



Wire frame

Bar stool.

CV



Bench

L2 / L1B⁴ 2-seat / 1 seat and table top

L3 / L2B⁴ 3-seat / 2-seat and table top

L4 / L3B⁴ 4-seat / 3-seat and table top

L5 / L4B⁴ 5-seat / 4-seat and table top

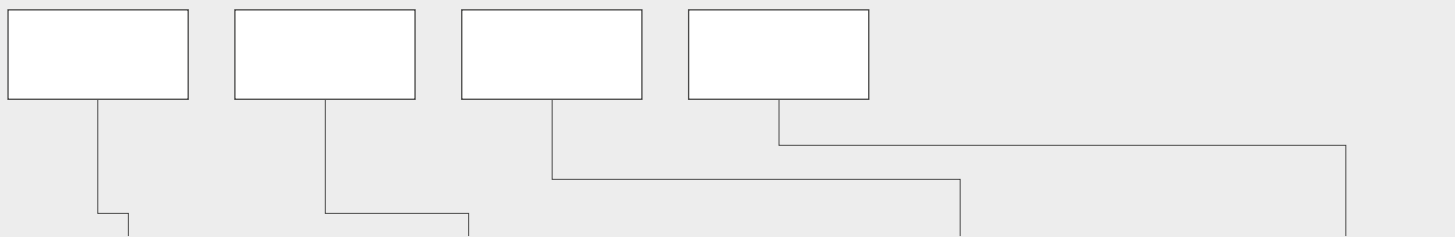









Frame colour

Armrests / Table top⁵

Shell colour / armpad colour⁶

Upholstery

	BLACK
	METALLIC
	CHROME
	SATINE

 <p>Plastic (ABS) Applicable for H, V3 versions.</p> <p>2P</p>	 <p>Plywood Applicable for H, V3 versions.</p> <p>2P</p>
 <p>Plastic (ABS) Applicable for V1, VN1 versions.</p> <p>2P</p>	 <p>Table top Always assembled on the right side of the chair.</p> <p>2PB</p>

HPL Laminate	Natural modified veneer	Lacquer
 LW01 White	 HM10 Bleached oak	 H8
 LW02 Black	 HM11 Classic oak	 H6
 LW04 Grey	 HM12 Cardinal oak	 H7
	 HM30 Teak	 H12
	 HM20 Wenge classic	 H11
		 H5

Type & colour

SYMBOL

Additional

Glides

HARD
For soft floors.

FELT
For hard floors.

TEFLON
Universal.

¹ Not applicable for CV version.

² Available for sale in the third quarter of 2017.

³ In versions on cantilever (V1/V2/V3/VN1) it is possible to order the chair without glides.

⁴ Benches are available with table top instead of seat.
Wooden table tops - standard colours of lacquer (H5, H6, H7, H8, H11, H12).
Table top colours of HPL (LW): LW01 (white), LW02 (black), LW04 (grey).
Table top colours of natural modified veneers (HM): HM10 (bleached oak), HM11 (classic oak), HM12 (cardinal oak), HM20 (wenge classic), HM30 (teak).

⁵ Not applicable for CV, V2 versions and benches.

⁶ Option available only in K4. The rest of the models take armpads in the same finish as the shell.

Accessories

When ordering, please use code symbols.

Numbering

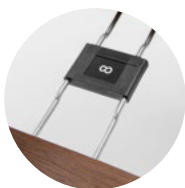

Chair numbering Type A

Applicable for H, V3 versions

ZA 1-10 Numbers 1-10 (a set)

ZA 11-20 Numbers 11-20 (a set)

ZA 21-30 Numbers 21-30 (a set)



Chair numbering Type B

ZB 1-10 Numbers 1-10 (a set)

ZB 11-20 Numbers 11-20 (a set)

ZB 21-30 Numbers 21-30 (a set)



Rows numbering

ZC 1-10 Numbers 1-10 (a set)

ZC 11-20 Numbers 11-20 (a set)

Magnetic handle



Magnetic handle for disassembly of the numbering

MH

Cut-out handle



Handle

C

Joining in rows

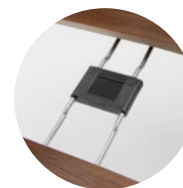

Linking part for H, V3 versions¹



Linking part for V1, VN1, V2 versions

¹ The linking part is suitable for H, V3 versions.
The linking part is an integral part of the chair, therefore it cannot be purchased and assembled at a later stage.

"Anti-panic" system^{2,3}



"Anti-panic" connectors

APA

for chairs without armrests

APB

for chairs with armrests



"Anti-panic" system
for connecting rows

APD

² Available colours: black, metallic.

³ "Anti-panic" system is available for 4-legged versions only (H/H 2P/H 2PB).

Trolley for transportation⁴



Trolley without a handle

CT



Trolley with a handle

CTH

⁴ Available colours: black, metallic. Always with soft castors.

Distance keeping elements⁵



Distance keeping element
preventing touching the wall
by the backrests of benches

D1



Distance keeping elements
preventing touching of backrests
of adjacent benches

D2

⁵ Available colours: black, metallic.

Profim and the Environment

In our operation we follow the sustainability principle. We operate in a responsible manner for the benefit of our customers, employees, suppliers, and the local community, but we always respect the environment.



Design and Development

A carefully considered design means a timeless and robust product that will serve the user for many years.

Com chairs are designed in a way that allow us to produce them with the smallest possible amount of materials and components, allowing for easy recycling at the end of the life cycle. It is also important to design the production process in an optimal way, so that the amount of wasted raw materials is minimized.

Designed in order to minimize the amount of hazardous substances used for production (such as chrome, cadmium or mercury).



Materials and Components

Materials and raw materials used for production must not only meet certain quality criteria, but also cannot contain hazardous compounds, harmful to humans and the environment (such as PVC, chrome(VI), mercury, lead).

Polyurethane foams do not contain organic compounds (e.g. CFC, PFC, H-CFC).

All wood-based raw materials that we use come from responsible and regulated forest industries. We are FSC® certified.

We work closely with our suppliers to reduce our collective impact on the environment. We encourage them to optimize processes and require that they conform to a number of environmental standards.



Production and Waste Management

We use environmentally-friendly technologies; our chrome-plating facility uses the eco-friendly Chromium(III) technology; the paint shop uses an eco-friendly, certified powder paint.

We optimize and reduce electricity consumption, and make sure that process water is reused in the production process.

Production waste is segregated for recycling and only sent to authorized parties; some of our waste is reused in the process.

Product packaging is made of recycled cardboard.



Delivery Logistics and Transport

We manage the transport fleet on our own, which allows us to optimize the use of trucks delivering our products to the clients and analyze transport on the go in terms of route selection in order to minimize fuel consumption. In addition, we combine deliveries with material pickups from our suppliers.

With the support of specialized information systems we can manage shipments in order to maximize vehicle capacity.

In order to achieve our goals, we have implemented Environmental Management System based on the ISO 14001 standard, which allows for a comprehensive approach to ecology.

We take into consideration and evaluate the way Com products affect the environment during their entire life cycle, including design, implementation, and production, as well as order processing and delivery, use, and recycling.



Using the Finished Product

All Com chairs come with a 5-year warranty, even though they can be used a lot longer, due to their high quality and durability.

Using the chair does not cause any effects that could be harmful to the environment or human health.



Recycling Used Products

Com chairs can be dismantled with standard, generally available tools.

The cardboard packaging is 100% recyclable.

Com

Product Environmental Information

(for Com K11H)

Materials used:

Metals	kg	%
Steel	2.42	46.8
Plastics	kg	%
Polypropylene (PP)	0.35	6.8
Wood	kg	%
Wood	2.40	46.4
Weight	5.17	100

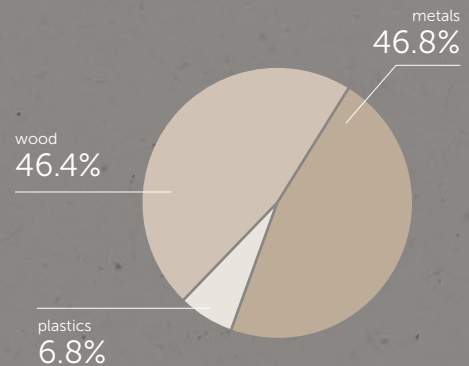

Recyclable content



This product contains no chemical compounds harmful to human health or the environment (including PVC, chromium (VI), mercury or lead).

Measurements

The measurements are approximate and can differ depending on the product configuration.
 Measuring methodology is available at this link: www.profim.eu/Measuring_methodology.pdf

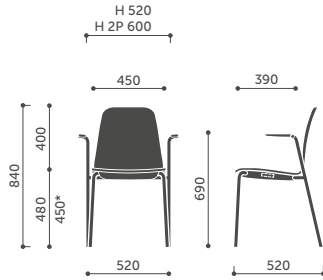

K11H / K12H / K13H
 K11H 2P / K12H 2P / K13H 2P

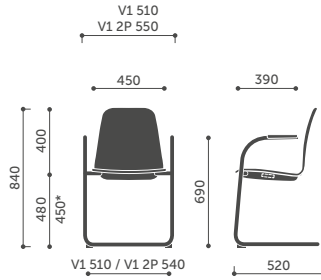

V1 510 / V1 2P 550
 V1 510 / V1 2P 540

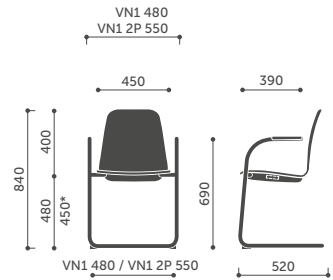

VN1 480 / VN1 2P 550
 K11VN1 / K12VN1 / K13VN1
 K11VN1 2P / K12VN1 2P / K13VN1 2P

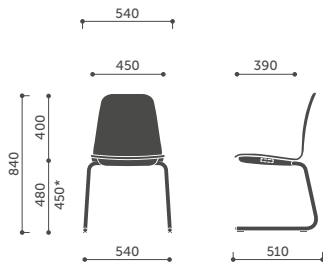

K11V2 / K12V2 / K13V2

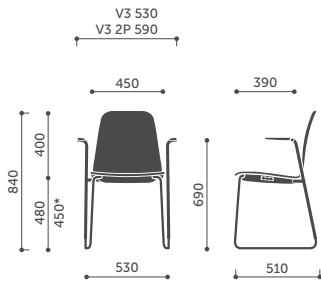

V3 530 / V3 2P 590
 K11V3 / K12V3 / K13V3
 K11V3 2P / K12V3 2P / K13V3 2P

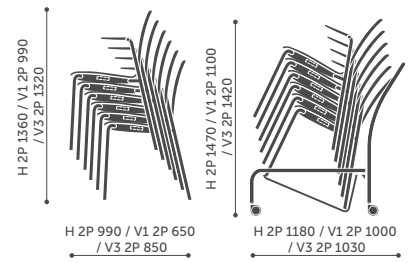

stacking K11 / K12 / K13

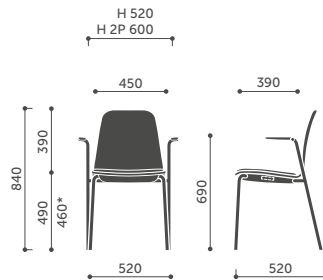

K21H / K22H / K23H
 K21H 2P / K22H 2P / K23H 2P

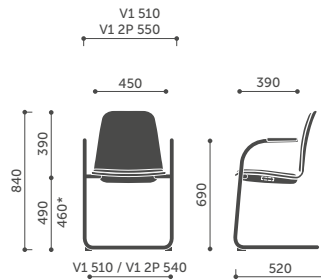

V1 510 / V1 2P 550
 K21V1 / K22V1 / K23V1
 K21V1 2P / K22V1 2P / K23V1 2P

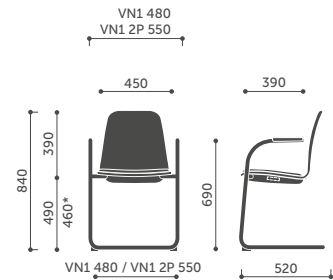

VN1 480 / VN1 2P 550
 K21VN1 / K22VN1 / K23VN1
 K21VN1 2P / K22VN1 2P / K23VN1 2P

* Seat height is measured according to PN EN 16139 norm (with seat burden).



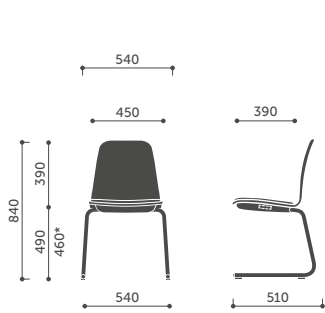

K21V2 / K22V2 / K23V2

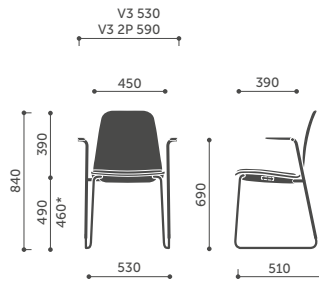

V3 530
V3 2P 590
K21V3 / K22V3 / K23V3
K21V3 2P / K22V3 2P / K23V3 2P

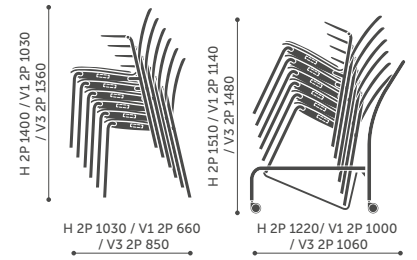

stacking K21 / K22 / K23

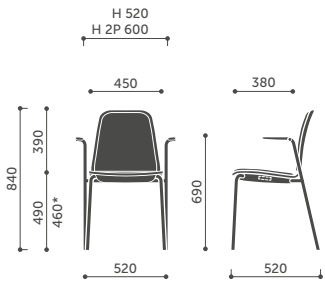

K31H / K32H / K33H
K31H 2P / K32H 2P / K33H 2P

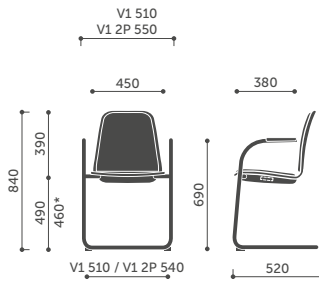

V1 510
V1 2P 550
K31V1 / K32V1 / K33V1
K31V1 2P / K32V1 2P / K33V1 2P

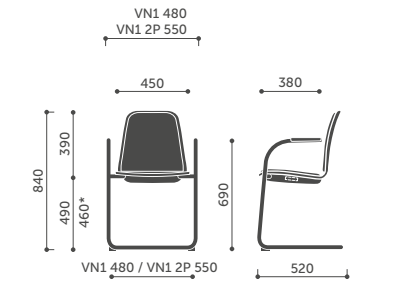

VN1 480
VN1 2P 550
K31VN1 / K32VN1 / K33VN1
K31VN1 2P / K32VN1 2P / K33VN1 2P

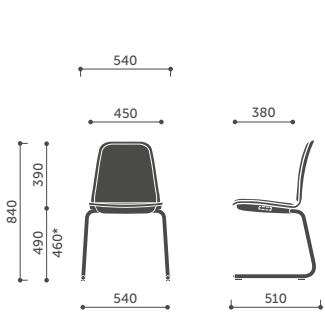

K31V2 / K32V2 / K33V2

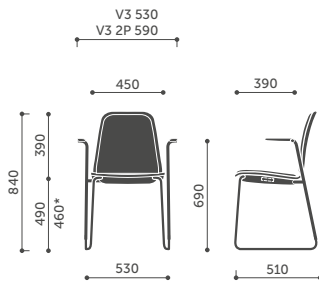

V3 530
V3 2P 590
K31V3 / K32V3 / K33V3
K31V3 2P / K32V3 2P / K33V3 2P

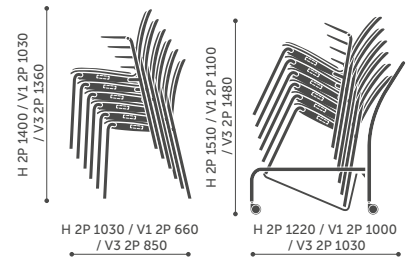

stacking K31 / K32 / K33

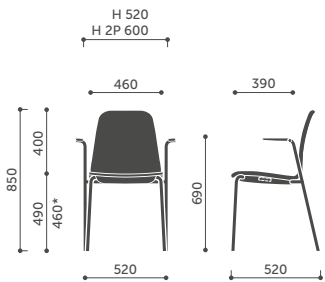

K41H / K42H / K43H
K41H 2P / K42H 2P / K43H 2P

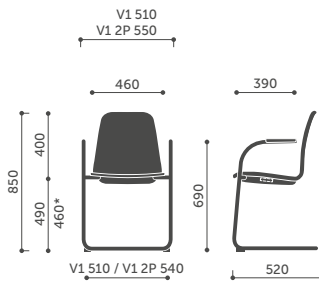

V1 510
V1 2P 550
K41V1 / K42V1 / K43V1
K41V1 2P / K42V1 2P / K43V1 2P

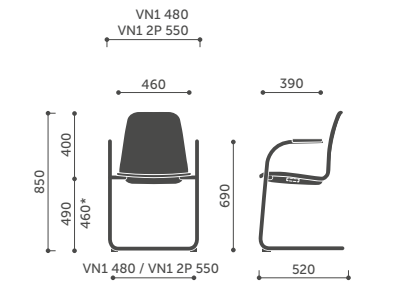

VN1 480
VN1 2P 550
K41VN1 / K42VN1 / K43VN1
K41VN1 2P / K42VN1 2P / K43VN1 2P

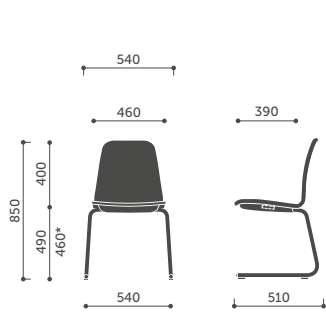

K41V2 / K42V2 / K43V2

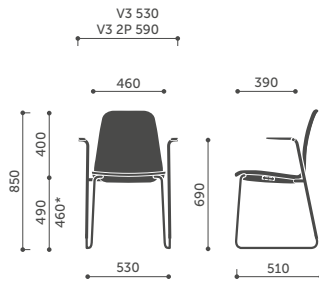

K41V3 / K42V3 / K43V3
K41V3 2P / K42V3 2P / K43V3 2P

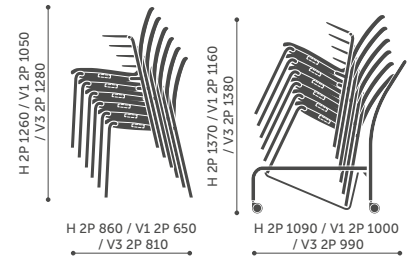

stacking K41 / K42 / K43

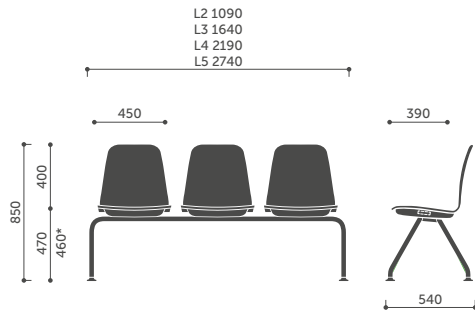

K11L / K12L / K13L

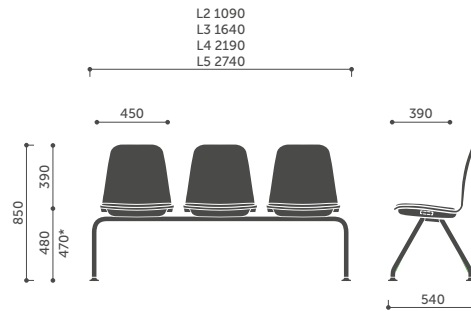

K21L / K22L / K23L

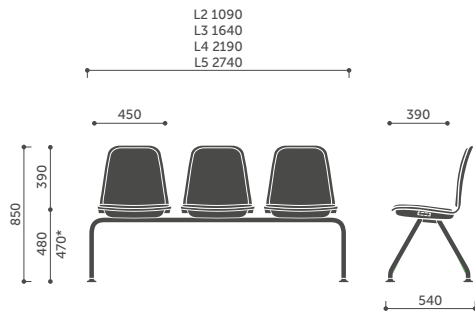

K31L / K32L / K33L

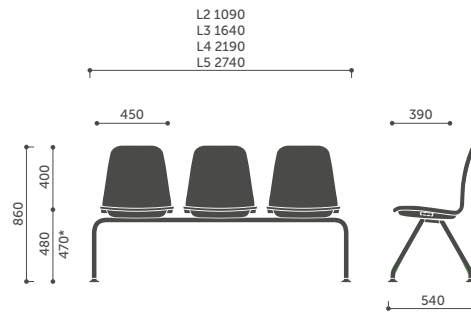

K41L / K42L / K43L



CT

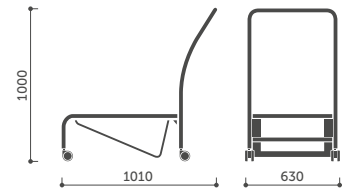

CTH

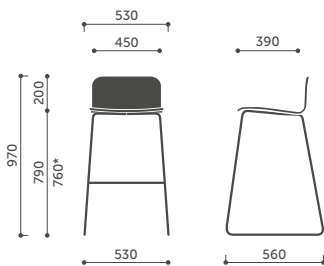

K12CV

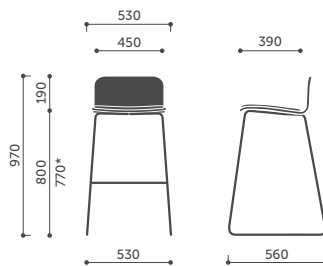

K22CV

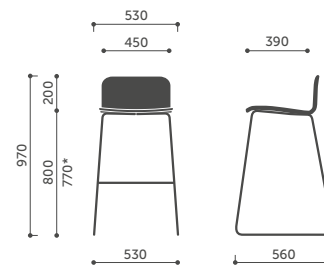

K42CV

11H (+2P)	12H (+2P)	13H (+2P)	x15
11V1 (+2P)	12V1 (+2P)	13V1 (+2P)	x5
11V2	12V2	13V2	x5
11V3 (+2P)	12V3 (+2P)	13V3 (+2P)	x15
21H (+2P)	22H (+2P)	23H (+2P)	x12
21V1 (+2P)	22V1 (+2P)	23V1 (+2P)	x5
21V2	22V2	23V2	x5
21V3 (+2P)	22V3 (+2P)	23V3 (+2P)	x12
31H (+2P)	32H (+2P)	33H (+2P)	x12
31V1 (+2P)	32V1 (+2P)	33V1 (+2P)	x5
31V2	32V2	33V2	x5
31V3 (+2P)	32V3 (+2P)	33V3 (+2P)	x12
41H (+2P)	42H (+2P)	43H (+2P)	x10
41V1 (+2P)	42V1 (+2P)	43V1 (+2P)	x5
41V2	42V2	43V2	x5
41V3 (+2P)	42V3 (+2P)	43V3 (+2P)	x10



11H (+2P)	12H (+2P)	13H (+2P)	x15
11V1 (+2P)	12V1 (+2P)	13V1 (+2P)	x5
11V2	12V2	13V2	x5
11V3 (+2P)	12V3 (+2P)	13V3 (+2P)	x15
21H (+2P)	22H (+2P)	23H (+2P)	x12
21V1 (+2P)	22V1 (+2P)	23V1 (+2P)	x5
21V2	22V2	23V2	x5
21V3 (+2P)	22V3 (+2P)	23V3 (+2P)	x12
31H (+2P)	32H (+2P)	33H (+2P)	x12
31V1 (+2P)	32V1 (+2P)	33V1 (+2P)	x5
31V2	32V2	33V2	x5
31V3 (+2P)	32V3 (+2P)	33V3 (+2P)	x12
41H (+2P)	42H (+2P)	43H (+2P)	x10
41V1 (+2P)	42V1 (+2P)	43V1 (+2P)	x5
41V2	42V2	43V2	x5
41V3 (+2P)	42V3 (+2P)	43V3 (+2P)	x10



11H 2PB	12H 2PB	13H 2PB	x5
21H 2PB	22H 2PB	23H 2PB	x5
31H 2PB	32H 2PB	33H 2PB	x5
41H 2PB	42H 2PB	43H 2PB	x5



11H 2PB	12H 2PB	13H 2PB	x5
21H 2PB	22H 2PB	23H 2PB	x5
31H 2PB	32H 2PB	33H 2PB	x5
41H 2PB	42H 2PB	43H 2PB	x5



For more information about the product
please scan the QR code.



www.profim.eu

The producer reserves the right to conduct construction changes and improvements of the products.
Colours presented in the catalogue may vary from the original colours of furniture.



CHROMIUM (III)
Eco-Friendly Technology

CHROM (III)
Umweltfreundliche
Technologie

