

Chic, Chic Air

Chic Tables



profim



"Both Chic and Chic Air try to propose a good answer to a heavy contract furniture in a domestic suit. Chic tends to be more sensual, elegant, classic, classy, as Chic Air fits a minimalistic approach with character and universality."

Christophe Pillet
Product Designer

Chic Air collection:



reddot design award
winner 2017



Minimalism. Lightness. Elegance.

Chic

Lightness, elegance and universal design – these are the distinctive features of the Chic collection. A delicate cross-section of the chair makes it look unusually light. The Chic family includes a chair with a thin, metal frame, either with 4-legged base or wooden legs, as well as a swivel armchair with memory swivel return feature or regular with glides.









Unusual spaces call for unique furniture. Our impressive chairs and armchairs from the Chic collection do not overwhelm the interior, yet their subtle profile and pure form are conspicuous.

Elegance and harmony

The Chic chairs are compact in form and universal in style, which is essential in less formal, but still elegant spaces, such as hotel rooms, cafés, restaurants, lounges or office lobbies. There are tables to go with the chairs: a well-matched set which makes any space look harmonious.





Functionality and quality

4-legged chairs are a perfect match for spaces where functionality and beauty are equally important, such as conference rooms and representative office spaces. Memory swivel return feature allows keeping chairs in order.







A moment to relax

The aesthetic and subtle form of Chic armchair invites you to unwind and is perfect for meetings in a casual atmosphere.

The armchairs are designed for relaxation zones. The profiled shape of shell and soft foam allow you to rest in full comfort.



Chic Air

The Chic Air furniture is extraordinarily elegant and distinguished by minimalistic, sophisticated form. The collection includes compact chairs and benches as well as matching distinctive armchairs. Every model is available with a thin, metal frame or on wooden legs.





reddot design award
winner 2017





Refined and carefully considered lines as well as original foam shape, hard to achieve, make the chair a real eye-catcher in the room. Chic Air was inspired by the need for seats matching modern and minimalistic spaces.







Geometry of shape

The collection is based on angular, geometric forms and on the delicate cross-section of the frame supporting the chair. The Chic Air armchairs are perfect for those who plan to furnish a lobby, office or lounge with unusually comfortable, distinctively designed chairs with top-notch seat finishing.



The perfect match

Original slim cross-sections of the Chic Air chairs are a result of an advanced process of joining two shells, while concealing their connecting elements. What makes the collection even more special is the possibility of joining two different kinds of upholstery – high quality leather on outer side and soft fabric inside.





Chic Tables

The collection includes a wide range of bases, shapes, heights and table-top sizes. Thanks to a large number of finishes available, tables may be customised. The tables will therefore match any space without disturbing its décor and integrity.



RR Tables



RR40



RR30



RR20



RR10

RH Tables



RH30



RH20

CR Tables



CR40



CR41

CS Tables



CS30



CS40



CS41



Stylish diversity

The Chic tables are a natural complement to the Chic and Chic Air furniture. Harmonious, elegant style and light form of tables and chairs create a holistic space arrangement. Four available table top finishes – ceramic, glass, wooden or metal – allow you to create the interior in any style.



Ceramics

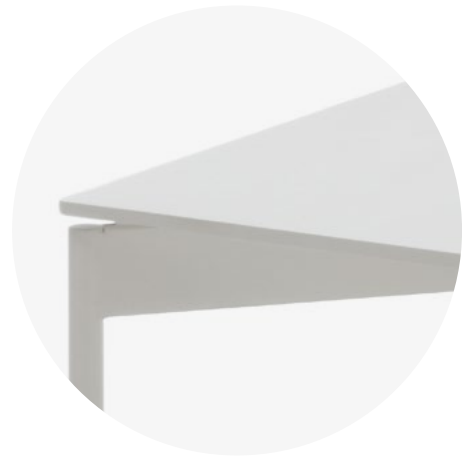

Metal

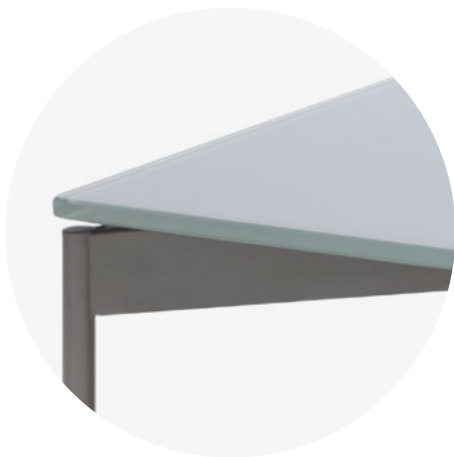

Tempered glass



Modified veneer

Configure your product

When ordering, please use code symbols.

Chic

Shell



Chair

20



Metal legs

H



Wooden legs

HW



Swivel, 4-star base

F



Armchair

10



Armchair

FU









Swivel armchair







FUS

Frame / Base

Frame / base colour ^{1, 2}

 BLACK	 METALLIC
 EPO1 White	 EPO2 Grey
 EPO3 Graphite	 CHROME
 SATINE	

Lacquer ³

 H8	 H6
 H7	 H12
 H11	 H5

Upholstery

Type & colour

SYMBOL

Additional

Glides

HARD

For soft floors.

FELT

For hard floors.

TEFLON

Universal.

Gaslift with memory,
without height adjustment

Standard:
applicable for 10FUS version.



Option: applicable for 20F version.



¹ Applicable for 20 version.

² F version available only in chrome.

³ Applicable for HW version.

Chic Air



Shell

Backrest and armrests

Frame

Frame colour

Upholstery

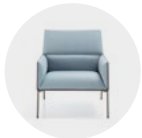

Armchair

A

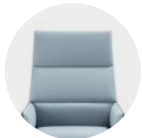

High backrest,
with armrests

10

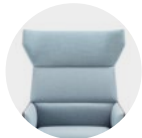

Wingback,
high backrest,
with armrests

11

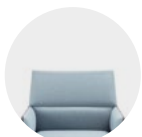

Low backrest,
with armrests

20

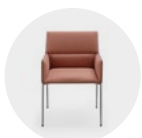

Chair

C



Low backrest,
with armrests

20



Low backrest,
without armrests

21



2-seat bench

B

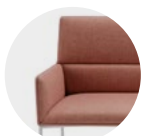

Low backrest,
with armrests

20



Metal legs

H



Wooden legs

HW



BLACK



METALLIC



EPO1

White



EPO2

Grey



EPO3

Graphite



CHROME



SATINE

Lacquer¹



H8



H6



H7



H12



H11



H5

Type & colour

SYMBOL

Option of mixing colours of the same fabric according to below scheme: A – inner part of the shell, B – outer part of the shell. In case of order of such option, following example should be specified: ST-5/ST-6 (where ST-5 – A, ST-6 – B).

It is possible to combine upholstery (Surface A) with Softline or leather (Surface B).

Additional

Glides

HARD

For soft floors.

FELT

For hard floors.

TEFLON

Universal.

¹ Applicable for HW version.

Configure your product

When ordering, please use code symbols.

Chic Tables ¹











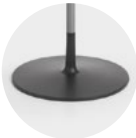





Frame / Base

Height

Frame colour ²

Table top



 Round RR	 h=480 mm 40	 h=660 mm 30
 h=740 mm 20	 h=1100 mm 10	
 Legs RH	 h=660 mm 30	 h=740 mm 20

 BLACK	 METALLIC
 EPO1 White	 EPO2 Grey
 EPO3 Graphite	 CHROME
 SATINE	



Tempered glass

 G1 Milky	 G2 Black	 G3 Taupe (RAL 7044)
 G4 Grey (RAL 7042)		



Ceramics

 CER1 White	 CER2 Grey	 CER3 Graphite
--------------------------------------------------------------------------------------------------------------	-------------------------------------------------------------------------------------------------------------	-----------------------------------------------------------------------------------------------------------------

Metal

 EPO1 White	 EPO2 Grey	 EPO3 Graphite
---------------------------------------------------------------------------------------------------------------	--------------------------------------------------------------------------------------------------------------	------------------------------------------------------------------------------------------------------------------

Modified veneer

 HM10 Bleached oak	 HM11 Classic oak	 HM12 Cardinal oak
 HM30 Teak	 HM20 Wenge classic	

Additional

Glides

HARD

For soft floors.

FELT

For hard floors.

TEFLON

Universal.

¹ Chic RH / RR tables with metal and ceramic table top (applies only if frame and top are made of EPO1, EPO2, EPO3, with hard or teflon glides) are suitable for outdoor use according to EN 12944-2 cat. C3.

² Frame colour in Chic Restaurant Tables RR applies to column only. Cast iron base always black.

Chic Tables



Table

Dimension

Frame colour

Table top



Square

CS



1200 x 1200
x 250 mm

41



800 x 800
x 250 mm

40



450 x 450
x 560 mm

30



Round

CR



Ø 1200 mm,
h=250 mm

41



Ø 800 mm,
h=250 mm

40



BLACK



METALLIC



EPO1

White



EPO2

Grey



EPO3

Graphite



CHROME



SATINE

Tempered glass



G1

Milky



G2

Black



G3

Taupe
(RAL 7044)



G4

Grey (RAL 7042)

Ceramics



CER1

White



CER2

Grey



CER3

Graphite

Metal¹



EPO1

White



EPO2

Grey



EPO3

Graphite

Modified veneer



HM10

Bleached oak

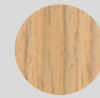

HM11

Classic oak



HM12

Cardinal oak



HM30

Teak



HM20

Wenge classic

Additional

Glides

HARD

For soft floors.

FELT

For hard floors.

TEFLON

Universal.

¹ Applicable for CS30 version.

Measurements

The measurements are approximate and can differ depending on the product configuration.
 Measuring methodology is available at this link: www.profim.eu/Measuring_methodology.pdf

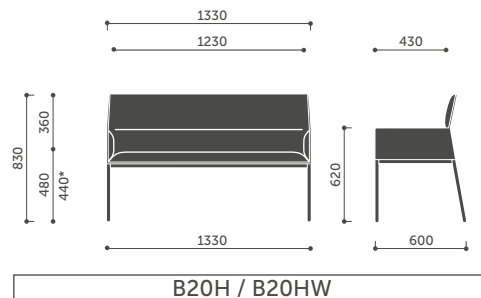
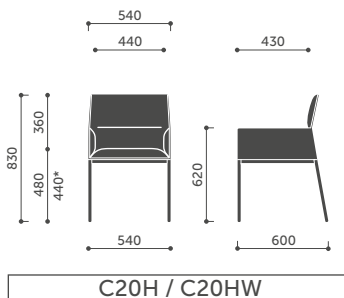
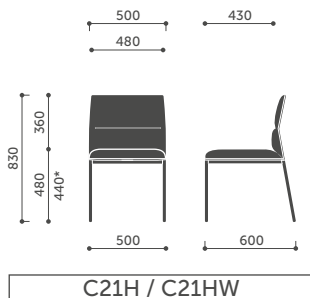
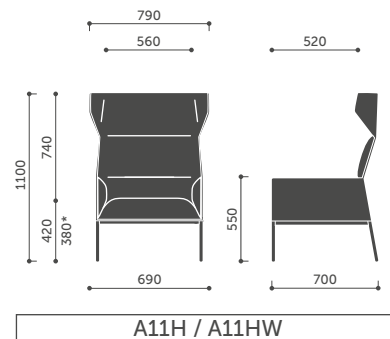
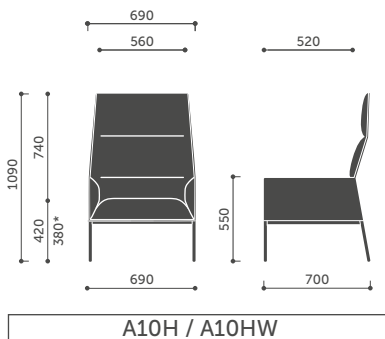
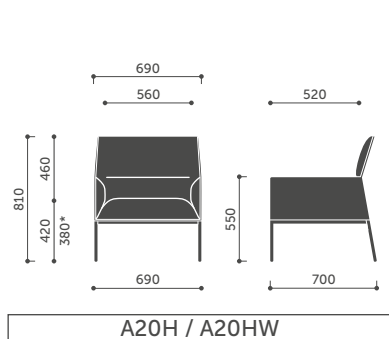
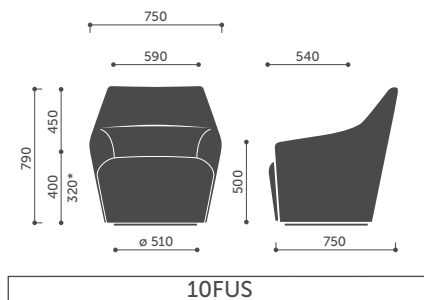
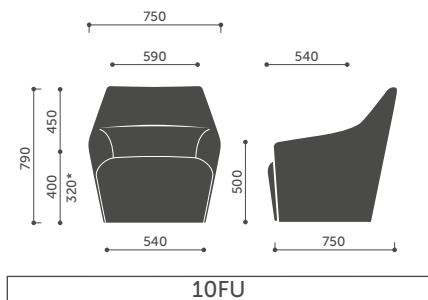
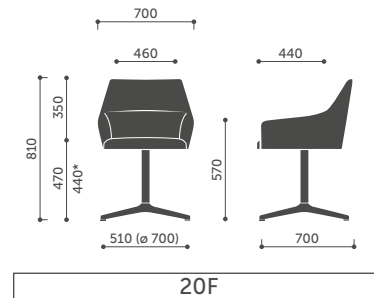
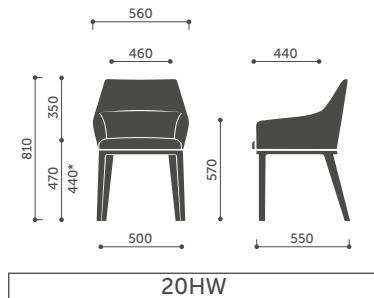
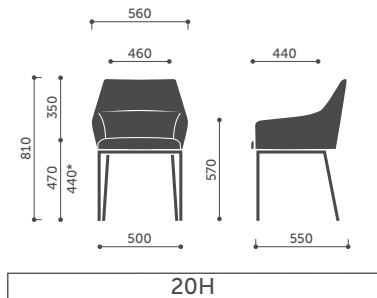

* Seat height is measured according to PN EN 16139 norm (with seat burden).

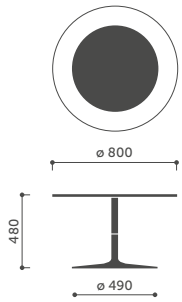

RR40

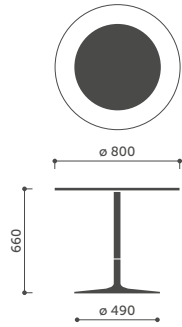

RR30

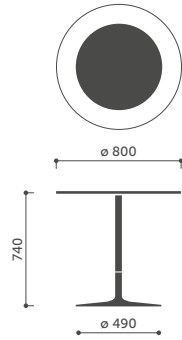

RR20

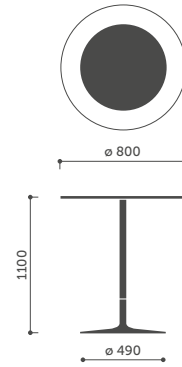

RR10

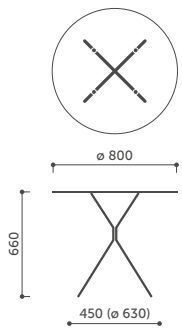

RH30

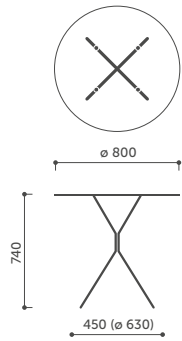

RH20

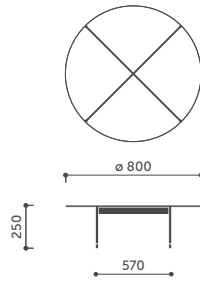

CR40

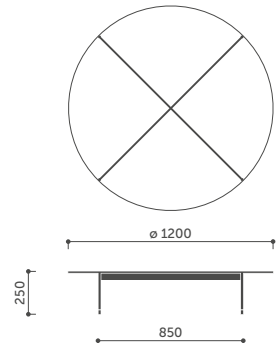

CR41

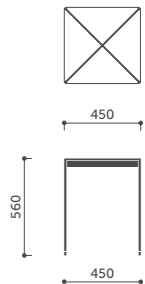

CS30

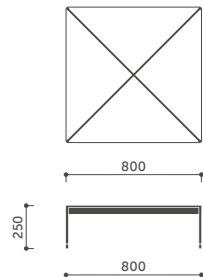

CS40

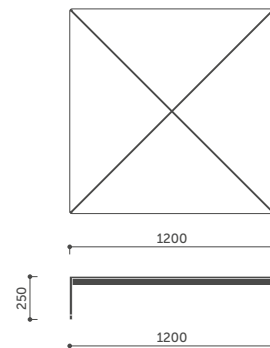

CS41



Profim and the Environment

In our operation we follow the sustainability principle. We operate in a responsible manner for the benefit of our customers, employees, suppliers, and the local community, but we always respect the environment.

In order to achieve our goals, we have implemented Environmental Management System based on the ISO 14001 standard, which allows for a comprehensive approach to ecology. We take into consideration and evaluate the way Chic products affect the environment during their entire life cycle.

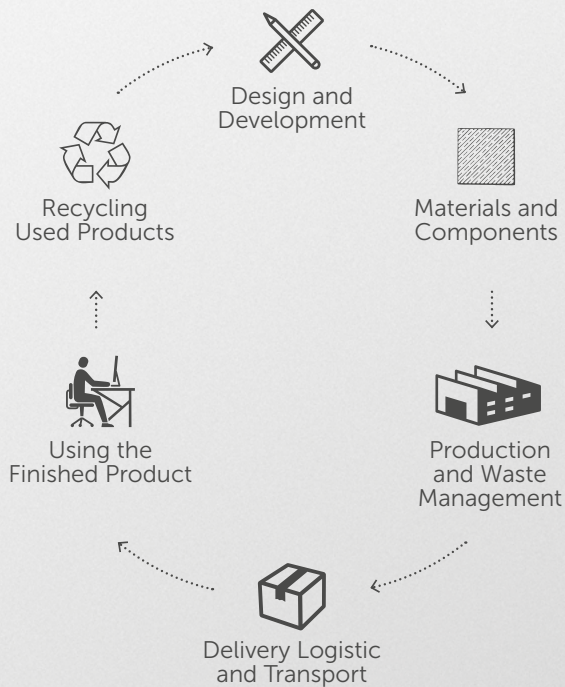

Chic

Product Environmental Information

(for Chic Air C20H)

Materials used:

Metals	kg	%
Steel	3.18	26.4
Plastics	kg	%
Plastics	0.14	1.1
Others	kg	%
Upholstery	0.92	7.6
Wood	5.96	49.5
PU Foam	1.84	15.4
Weight	12.04	100.0

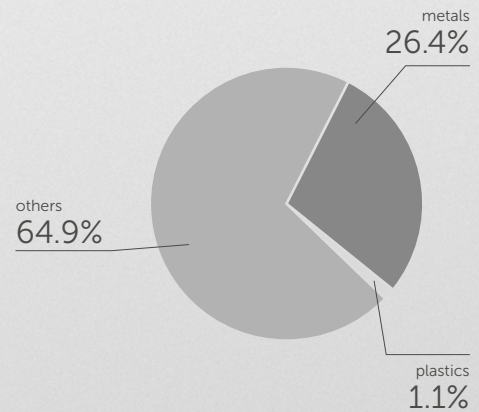

This product contains no chemical compounds harmful to human health or the environment (including PVC, chromium (VI), mercury or lead).

www.profim.eu

The producer reserves the right to conduct construction changes and improvements of the products.
Colours presented in the catalogue may vary from the original colours of furniture.



CHROMIUM (III)
Eco-Friendly Technology

CHROM (III)
Umweltfreundliche
Technologie

