

mPosition

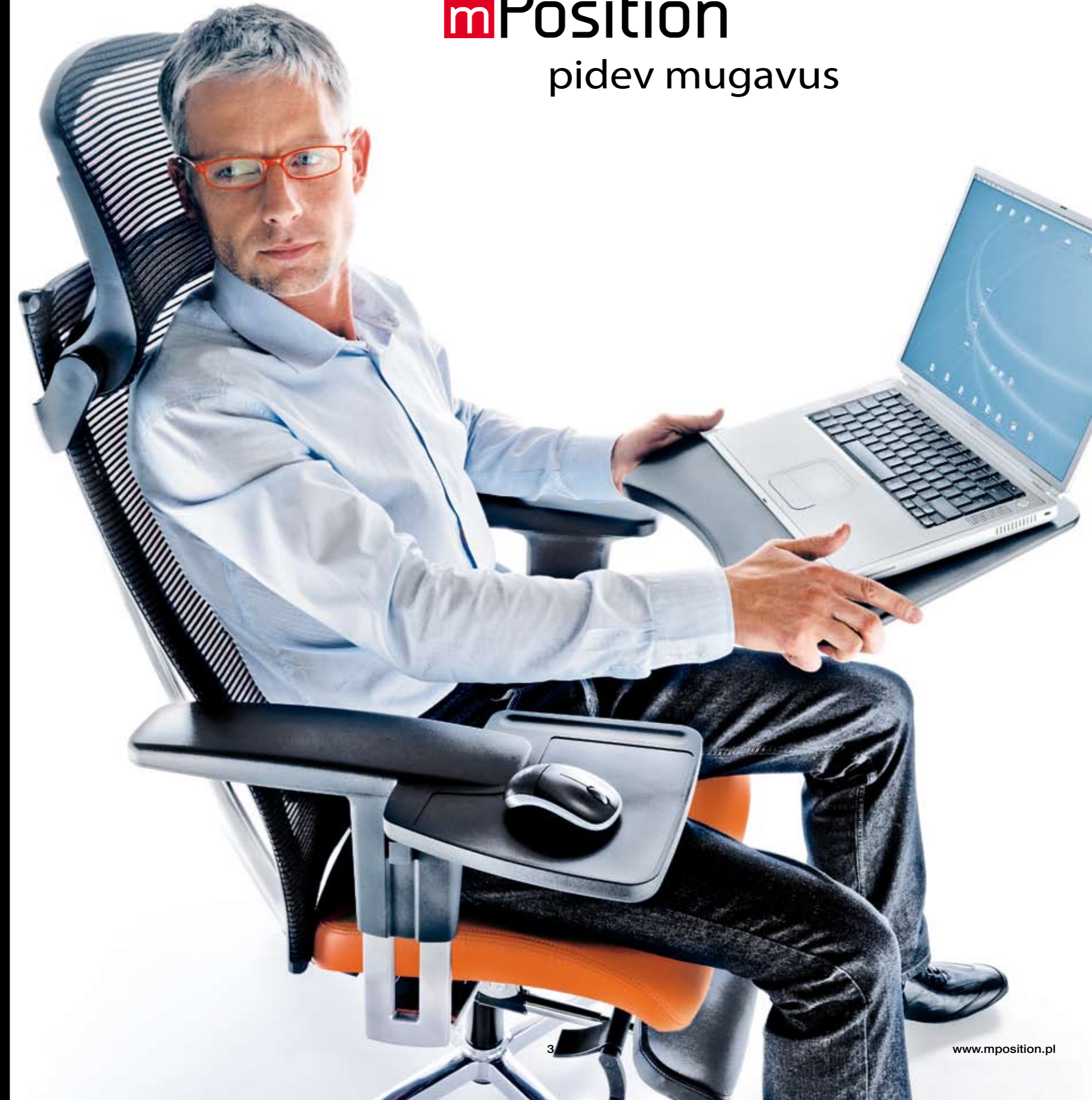

isegi kõige mugavamast asendist
tuleb aeg-ajalt muuta

mPosition
pidev mugavus



DESIGN: Studio 1:1 Jarosław Szymański

meble plus
PRODUKT
2012

DIAMENT
MEBLARSTWA
2012

**DOBRY
WZÓR**
2011

top
design
award
2011

3

www.mposition.pl



multifunktsionaalne
erinevad reguleerimis-
võimalused
mitu asendit

mPosition

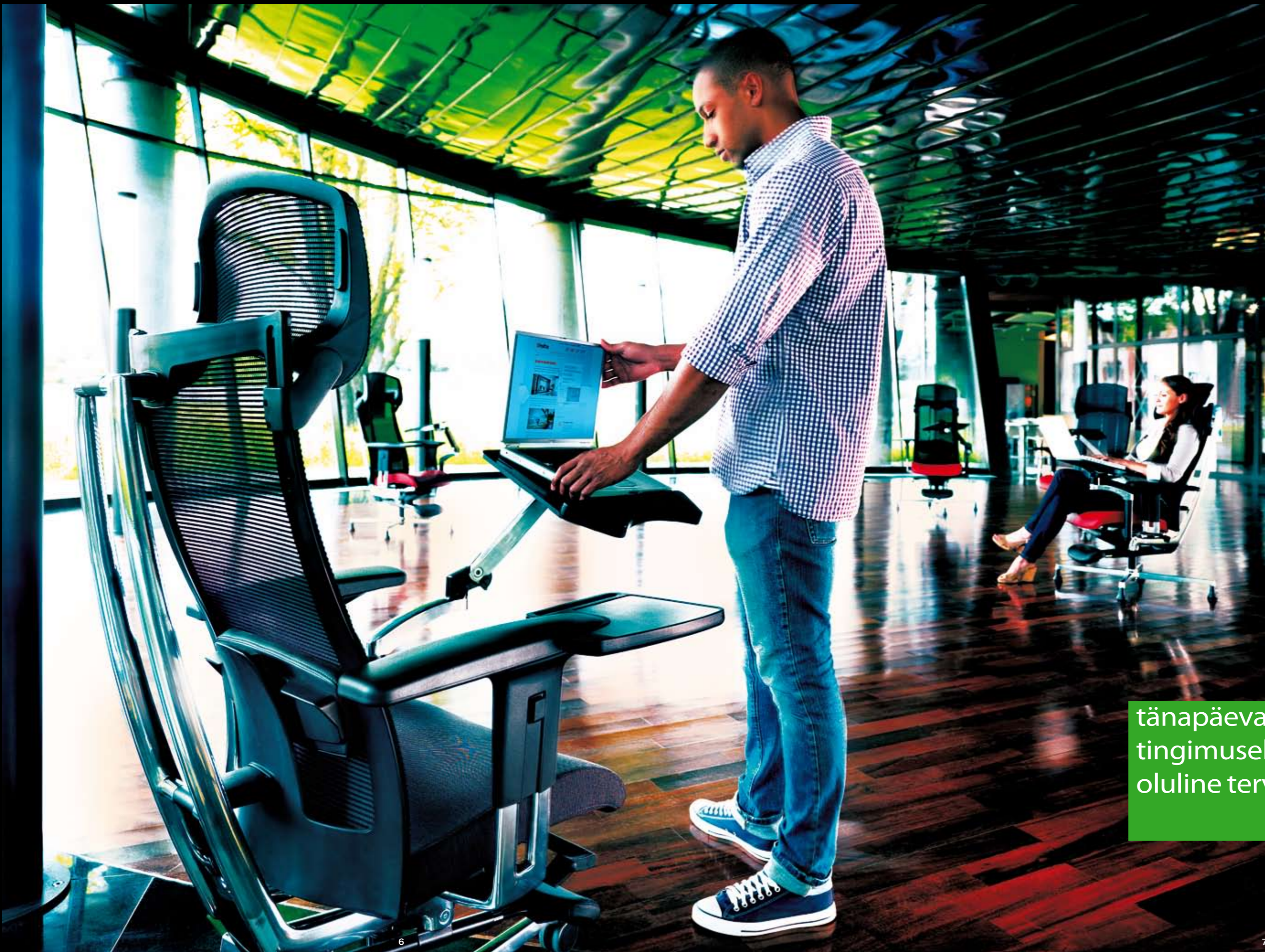

tänapäeval on mobiilsus üheks tingimuseks, et töötada mugavalt, mis on oluline tervise seisukohalt



mPosition
pidev mugavus



mPosition
eesmärk: mugavus



stabiilsus ja paindlikkus
mPosition



Töötage oma süle- või tahvelarvutiga mPosition toolis igas asendis – istudes, lamades või seistes

mPosition

sülearvuti laua reguleerimine

Mitmesse asendisse reguleeritav sülearvuti laud võimaldab leida kõige optimaalsema asendi.

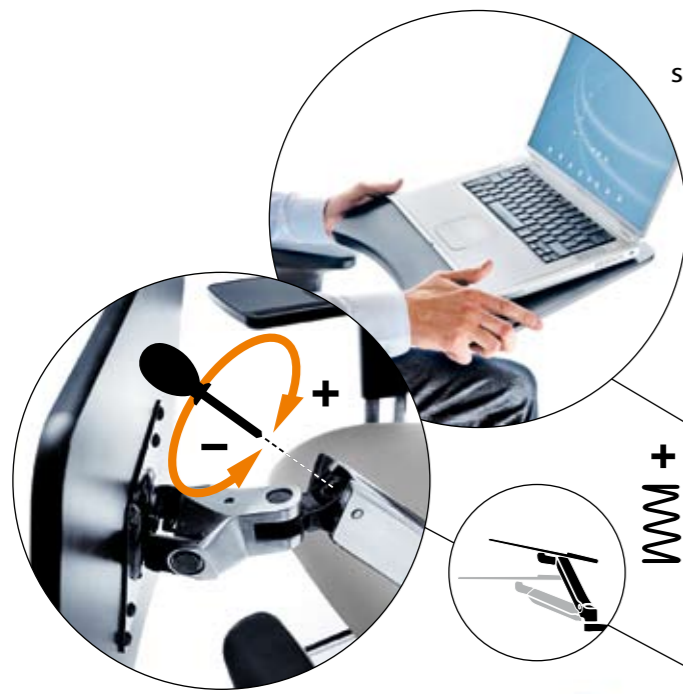

peatoe reguleerimine

Erinevale kõrgusele ja nurga alla reguleeritav peatugi võimaldab leida optimaalse peasendi sülearvutiga töötamiseks.

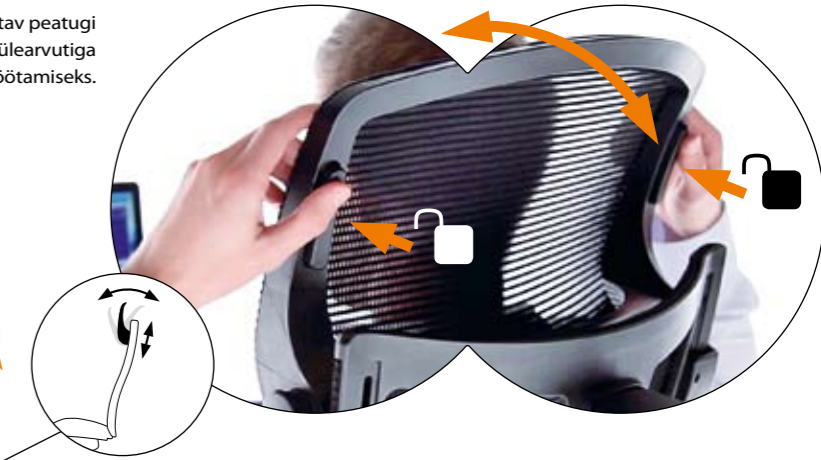

selgroo toe reguleerimine

Reguleeritava selgrootoega seljatugi. Läbipaistev võrgust seljatugi.



jalatoe reguleerimine

Pikendatav jalatugi tagab mugava toe jalgadele.



käetoe reguleerimine

Lai ja reguleeritav käetugi koos integreeritud hiirealusega tagab küünarnukile lõdvestunud asendi, samas kui ranne puhkab mugavalt klaviatuuril.



seljatoe nurga reguleerimine

Ergonoomiline mehhanism istme ja seljatoe nurga sünkroonselt reguleerimiseks.

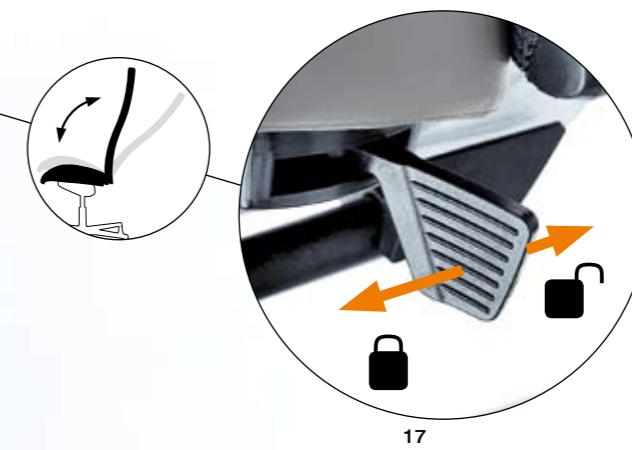

istme sügavuse reguleerimine

Profileeritud, istmissügavuse muutmisvõimalusega tooli on mugav reguleerida. Võimalus valida nahk- või tekstiilpolster.

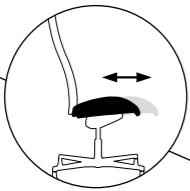

istme kõrguse reguleerimine

Istme kõrguse reguleerimine vastavalt kasutaja kasvule.

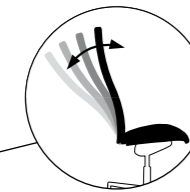
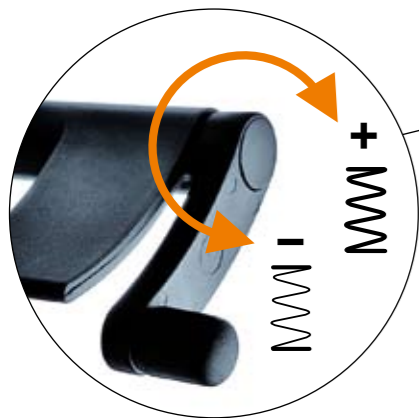
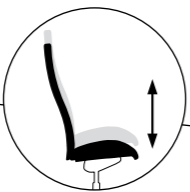
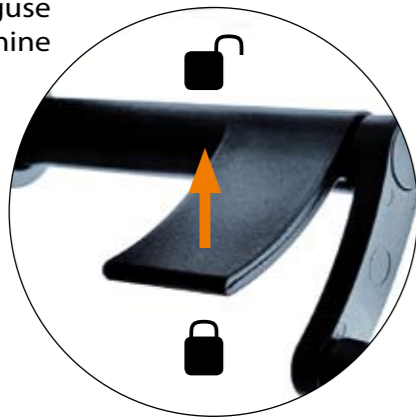

naaldumisega avaldatav jõud seljatoele

Seljatoe kalde pinge on reguleeritav vastavalt kasutaja kaalule.



mPosition

- * kogusügavus põhiasendis - 850mm
- * kogusügavus lamavas asendis - 1580mm
- * istme sügavuse reguleerimisvahemik - 45mm

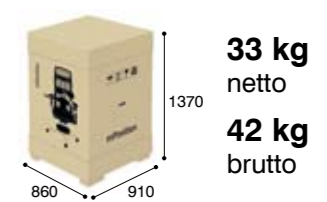

33 kg netto
42 kg brutto

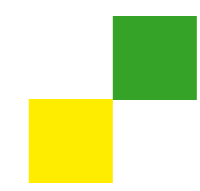

Rohkem infot tooli mehhanismide kohta saab tooliga kaasasolevast juhendist ja veebilehelt www.mposition.eu

**GARANTII
5 AASTAT**



www.mposition.pl

Tootja jätab endale õiguse tooteid muuta ja täiendada. Kataloogis toodud värvitoonid võivad tegelikkusest erineda.



INNOWACYJNA GOSPODARKA
NARODOWA STRATEGIA SPÓJNOŚCI



UNIA EUROPEJSKA
EUROPEJSKI FUNDUSZ
ROZWOJU REGIONALNEGO

